

In-line Blending Systems



In-line Blending





Blending

In-line Blending

In-line Blending is the controlled, continuous mixing of a number of components to produce a finished product of closely defined quality.

The quality of the product is controlled as it is made. This is invaluable in continuous process industries because the final product can be blended, analysed and loaded in a single process.

The alternative Batch blending is the main alternative. It involves sequentially introducing measured volumes of each component into a tank. The components are then mixed, analysed for quality and any adjustments made to the blend. This is time consuming and makes it necessary to store both pre-blended and finished products. Nevertheless, for small volumes and certain applications, this remains cost effective.

The specialists Jiskoot is an internationally acknowledged leader in the field of blending systems with over 40 years' experience in the design, manufacture and supply of customised turnkey measurement systems. Jiskoot has supplied blending systems to many of the world's major oil companies and has a reputation for



excellence and reliability. Our dedicated engineering team is able to select the best measurement and control equipment and design, manufacture, install and commission a turn-key

blending system with a performance guarantee.

Why In-line?



Diesel forwarding system

In-line blending has many advantages over batch blending.

Improved quality

The accuracy of an in-line blending system is governed by the accuracy of the individual component metering devices. Individual component accuracy better than 0.25% over the full metering range can easily be achieved.

Faster blending

By performing analysis and adjustment of the blend ratio on-line, the time consuming process of batch metering, tank mixing, product analysis and blend adjustment is eliminated. In-line blending greatly reduces process time, and provides a higher throughput potential.

Greater flexibility

Changes in shipping schedules and product specifications can be accommodated simply by selecting a different recipe from the controller. As the blender operates in real-time, configuring a new recipe is

quick and easy in comparison with the planning and stock movement necessary with batch blending. This allows you to offer a wide range of products and can provide a valuable competitive edge.



Crude oil blender

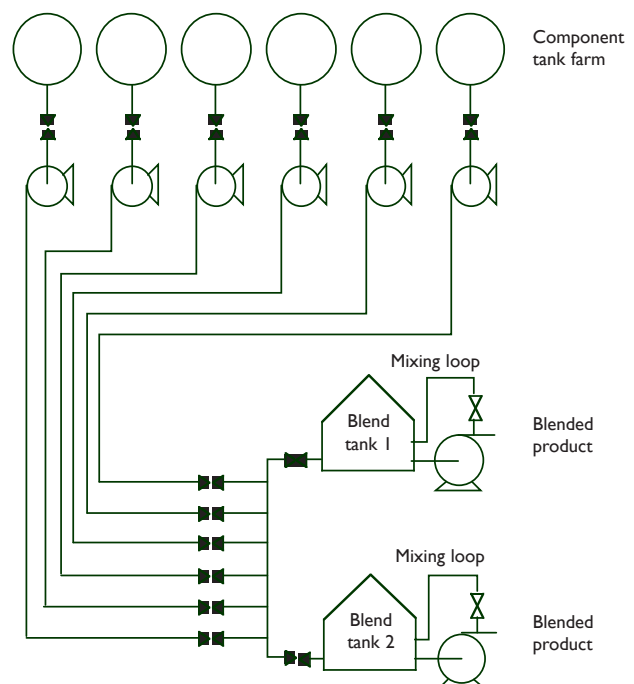

Typical batch blending system

Typical in-line blending system

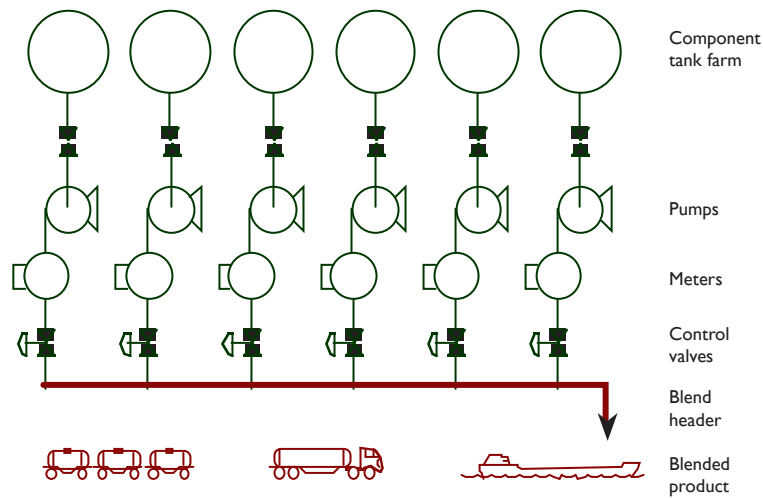

Reduced storage and capital lock-up

In-line blending produces a finished product almost instantaneously. It reduces the need for complicated production planning and there is no need to hold stocks of blended product. An in-line blender can feed products directly into road, rail or ocean tankers for shipment.

Reduced operating cost

Centralised control allows a single operator to control several blending operations simultaneously. Once initiated the blender will automatically produce the required final product.

Simplified plant layout

In-line blending enables a simplified plant layout to be achieved. In existing plants this can free tanks, pumps and pipelines for other duties and in new plants can considerably reduce capital costs.

Cost optimisation

Continuous metering, closed loop control and higher accuracy provides better product dispersion, better quality control and can substantially reduce the give-away of expensive components and additives. Substantial savings can be achieved in plants with a relatively low annual throughput.



Lube oil blender

In-line Blending



Crude oil blender

An in-line blending system comprises field equipment and a control system.

Field equipment

The field equipment (valves, meters, analysers, etc.) enables the components to be simultaneously metered into the 'blend header' to produce the final product. Products normally exit the blend header through a mixer and can be analysed to allow quality trim to be performed. In refineries, the components can be taken directly from process units, avoiding or reducing intermediate storage.

Control system

The control system monitors the outputs from the field equipment (flow rates, etc), performs calculations for meter linearisation, temperature compensation, etc. and feeds back the appropriate control signals to the field equipment to maintain the blending process within the required parameters (i.e. closed-loop control).

Blending control systems use either real-time or PLC (ladder logic) technology. Jiskoot supplies either technology depending on

application. However, the cost, response times and control provided by PLC technology has a number of restrictions and Jiskoot also offers a multi-tasking real-time dedicated blending controller, the Jiskoot InSight®.

The InSight® is an expandable controller designed for 2-40 stream applications that can either operate as a stand-alone device or in conjunction with a dedicated SCADA system and can be integrated with a plant-wide control system (DCS). The InSight® has a simple user interface with multi-level security allowing

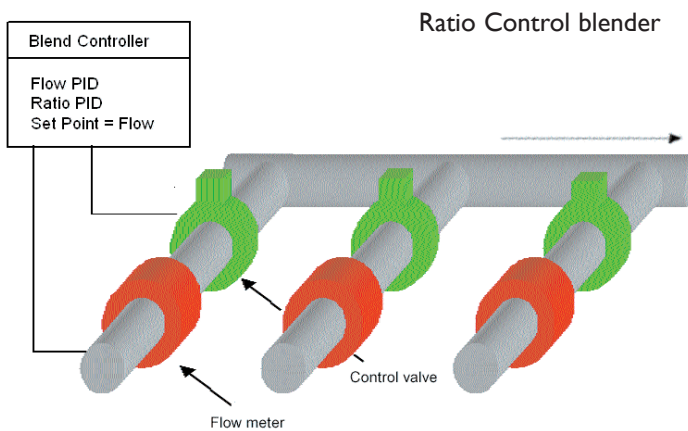

Ratio Control blender

equipment and the control signals from the controller back to the field equipment. The accuracy of a Ratio Control blender is determined by the measurement and control system.

Quality Trim

A Quality Trim blender produces a final product defined by a component ratio, but one or more analysers mounted at the exit to the blend header are used to 'trim' the quality of the final product by adjusting the component ratio. Product quality is continuously measured by the analyser(s) and the final product can be adjusted for parameters such as viscosity, density and octane. The accuracy of a Quality Trim blender is determined by the analyser(s).

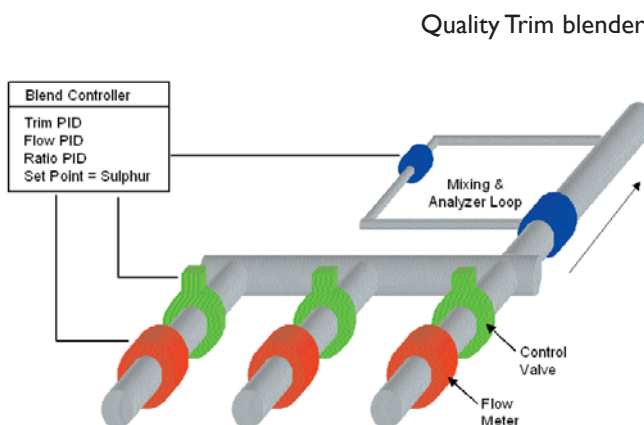

Quality Trim blender

access to recipe management, alarms, reports and batch information. The InSight® performs all the necessary linearisation, mass, volume and temperature computation and correction for accurate blending and has many unique features.

Blending Control

Selection of blender control philosophy is dependant upon the products being blended, the quality of feedstock, the final product specifications and the conditions under which the blender will operate. The control system and algorithms

define the stability and performance of the blender and selection of the correct control system is crucial to success. The two main types of control system for blending are Ratio Control and Quality Trim

Ratio Control

Ratio Control produces a product to an extremely accurate component ratio. The blender operates on either a fixed volumetric, or mass ratio. This ratio is maintained by the closed loop control between the flow signals from the field

Which to use?

Where the ratio and accuracy of each component stream is crucial, and the quality of the components consistent and unlikely to vary, Ratio Control is the preferred option. Quality Trim should be used in applications where there is a possibility of variations in the specification or quality of the component products supplied to the blender.

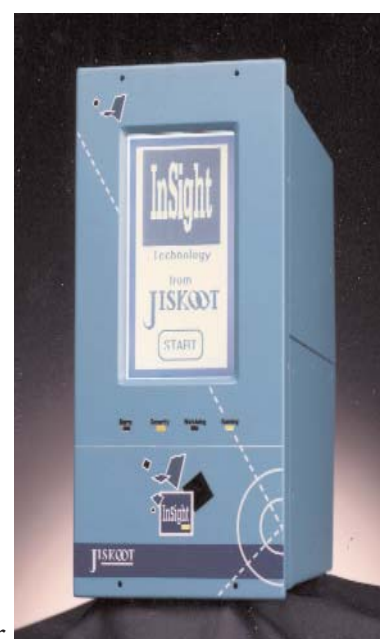

Jiskoot InSight® controller

Applications



Bunker blender

Jiskoot has supplied hundreds of blenders ranging from small two-stream fuel oil blenders to large multi-stream systems with analyser trim and SCADA control. Jiskoot blenders are supplied skid mounted, piped, wired and tested ready for installation at your site and guaranteed to perform to your specifications. Every blending application is unique and whilst the basic control principles remain the same, the configuration, selection of components and design varies for every application.

Additive injection

The addition of dyes and markers to gasoline and fuels is a statutory customs requirement in many countries. The problem of injecting additives into large

pipelines, where the ratio between the two streams can be in the order of 1:1000 or more, can be solved using a Jiskoot Flow Responsive Additive Proportioning (FRAP) System.

Crude oil blending

Low-grade crude oils can be blended with a higher grade for refining or export purposes. Often the blender uses an analyser to optimise the blended product for a specific component such as API gravity.

Diesel blending

Higher specification, lower cost diesel can be produced by in-line blending. Blenders can be designed to take major components directly from process units to minimise intermediate tank storage. Using analysers for sulphur

and cetane, the blended diesel can be produced to an exact environmental specification.

Ethanol blending

Ethanol is used in a wide range of industries. Before dispatch from a bonded plant, ethanol is normally denaturised. This is achieved by blending a variety of denaturants with the ethanol. Contamination of sequential loads with different denaturants must be avoided by incorporating a flush cycle in each batch.

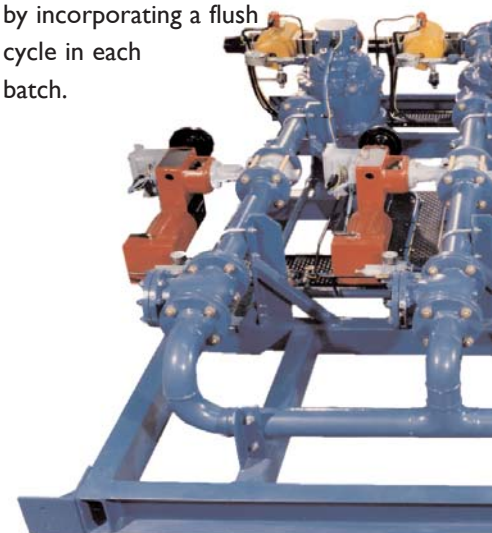
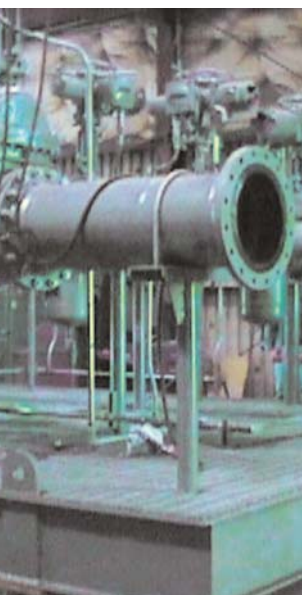

Fuel oil/bunker blending

Fuel oil (or 'bunkers') is blended globally. Blenders can be trailer mounted, mounted on fuel barge decks or shore mounted. They enable operators to produce any type of fuel oil within very close viscosity and volumetric tolerances from as few as two base components, normally HFO and MDO.

LPG blending

The demand for propane, butane and blends of these products has increased significantly. The search for CFC free propellants and the growth in liquid gas fuel production has given rise to the need for propane/butane blenders. Many systems use a densitometer mounted in the blend header to provide a signal to the blend controller which trims the blend to a specified density.

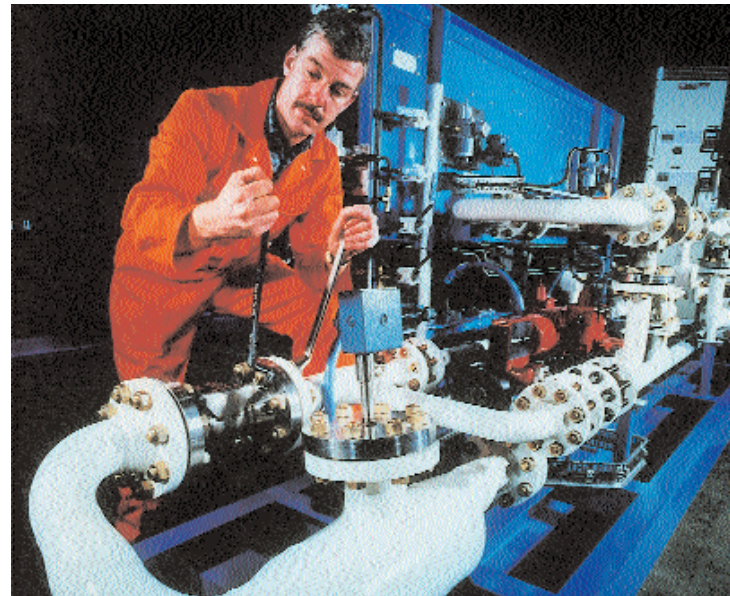

LPG blender



Mobile fuel oil blender

Lube oil blending and dehydration

Lube oil is one of the most demanding blending applications and considerable expertise is needed to produce a closely specified product from a wide range of ingredients without contamination. The patented Jiskoot lube oil dehydration system is unique and often employed to dry wet stocks to crackle test level prior to blending.

Lube oil blender and dehydration system

Bitumen blending

Bitumen blending is an arduous duty. The bitumen has to be heated and kept moving and local hot spots must be avoided to eliminate coking and meter damage. Jiskoot was the first company to use a double case meter in a recycle loop. Bitumen blenders need flushing facilities to avoid solidification after blending.

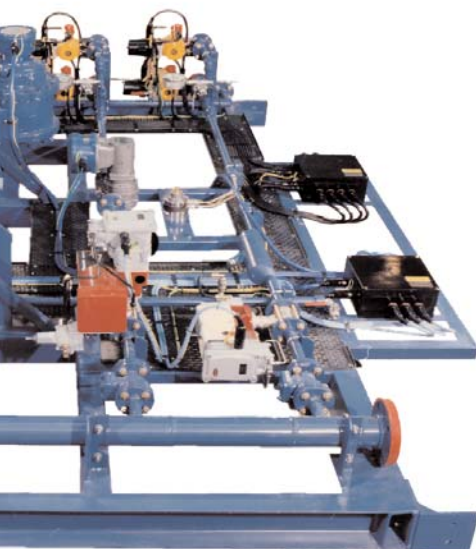

Ethanol blender



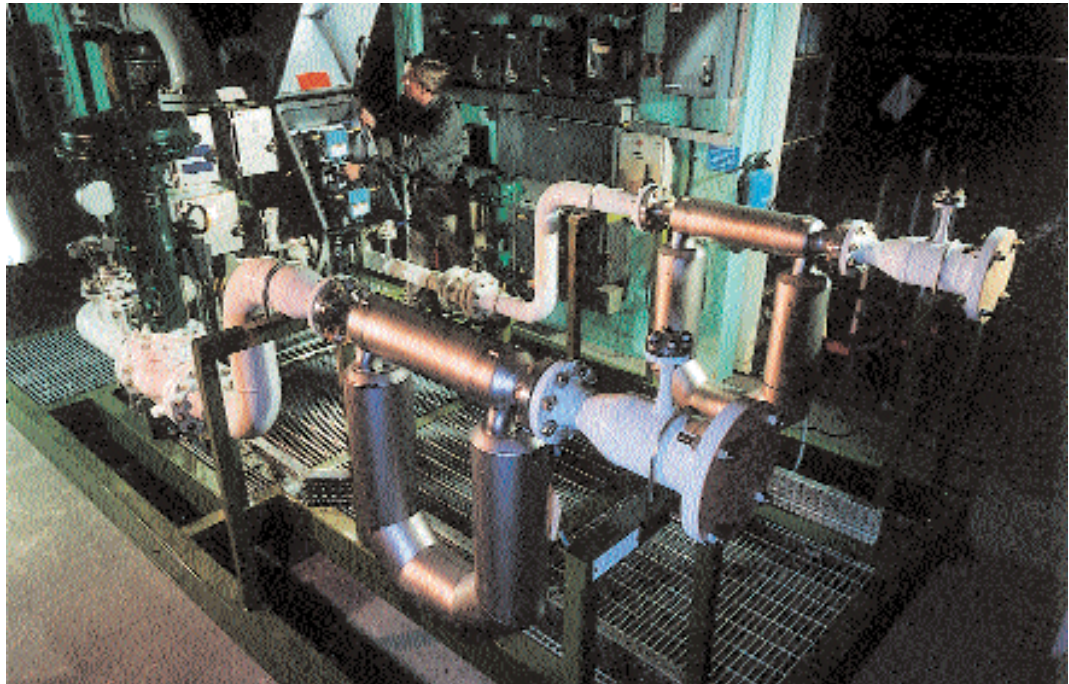

Propane and butane blender using mass flow meters

Jiskoot is an internationally acknowledged in-line blending specialist. The company does not manufacture any flow components and is therefore able to independently select and use the best field equipment for every application.

Jiskoot systems are designed and manufactured to the highest standard by engineers with years of practical experience.

Jiskoot is ISO 9000 accredited and all design and manufacturing is done in strict accordance with ISO procedures.

Jiskoot offers a 'turnkey' service which includes:

1. The design, manufacture and supply of instrumentation and

terminals tested under simulated operating conditions.

2. Selection, sizing, procurement, inspection and supply of all system equipment such as flow meters, control valves, pumps, etc.
3. Design and supply of completely self-contained piped and wired skids.
4. Supply of site termination drawings, wiring diagrams and operation/maintenance manuals.
5. Certification to site electrical/pneumatic/piping specifications.
6. Technical supervision of installation teams.
7. Commissioning services

and maintenance contracts.

8. Factory/on-site training of operating personnel.

Jiskoot can also provide a consultancy service for the evaluation of blending projects and applications.



UK
Jiskoot Quality Systems

Tel: +44 (0)1892 518000
Fax: +44 (0)1892 518100

Email: ms-jiskootuksales@c-a-m.com

USA
Jiskoot Quality Systems

Tel: +1 281 583 0583
Fax: +1 281 583 0587

Email: ms-jiskootusasales@c-a-m.com

Cameron
Measurement Systems

Tel: +1 281 582 9500
Fax: +1 281 582 9599

Email: ms-marketing@c-a-m.com

Jiskoot Quality Systems
A Cameron Company
www.jiskoot.com



www.c-a-m.com/flo